

Soft-Line

uniform 

Scala 0.7:1

3.29

- Ⓘ Esempi di posa
- Ⓓ Montagesysteme
- Ⓔ Sistemas de colocación
- Ⓕ Systèmes de pose
- Ⓚ Installation system

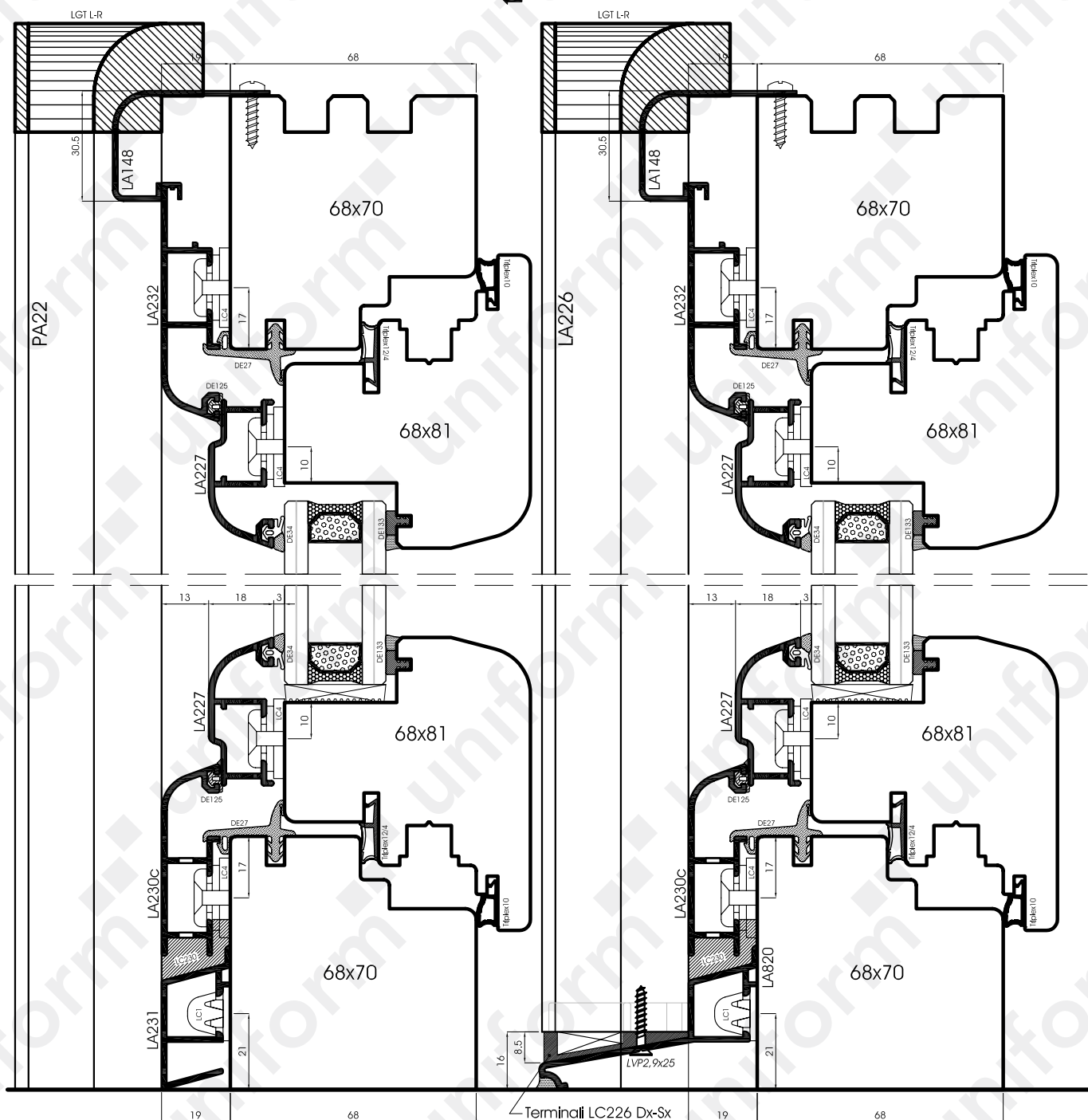
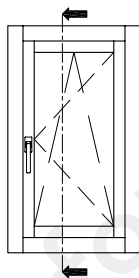

## Soft-Line

uniform

Scala 0.6:1

3.30

- Ⓘ Sezione verticale con guida avvolgibile PA22 e LA226
- Ⓓ Vertikalschnitt mit Rolladenführung PA22 und LA226
- Ⓔ Sección vertical con guía de persiana PA22 y LA226
- Ⓕ Coupe verticale avec coulisse volet roulant PA22 et LA226
- Ⓚ Vertical section with winding up guide PA22 and LA226

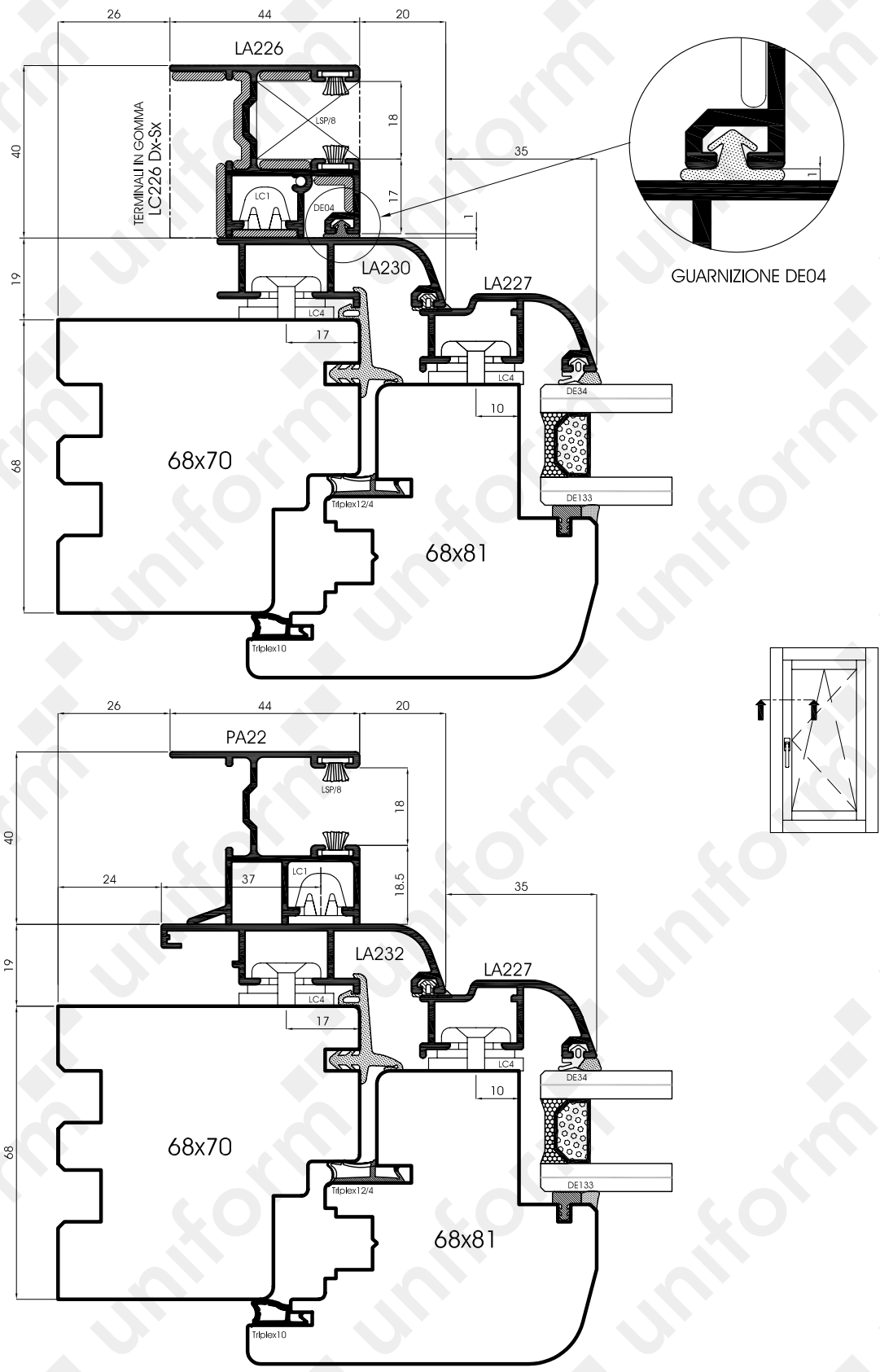

Soft-Line

uniform

Scala 0.7:1

3. 31

- Ⓘ Sezione orizzontale con guida avvolgibile PA22 e LA226
- Ⓓ Horizontalschnitt mit Rolladenführung PA22 und LA226
- Ⓔ Sección horizontal con guía de persiana PA22 y LA226
- Ⓕ Coupe horizontal avec coulisse volet roulant PA22 et LA226
- Ⓞ Horizontal section with winding up guides PA22 and LA226

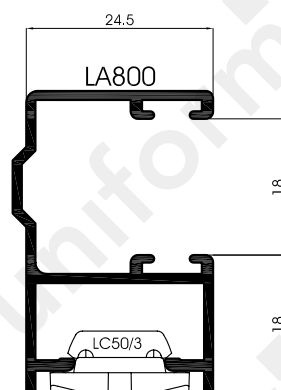
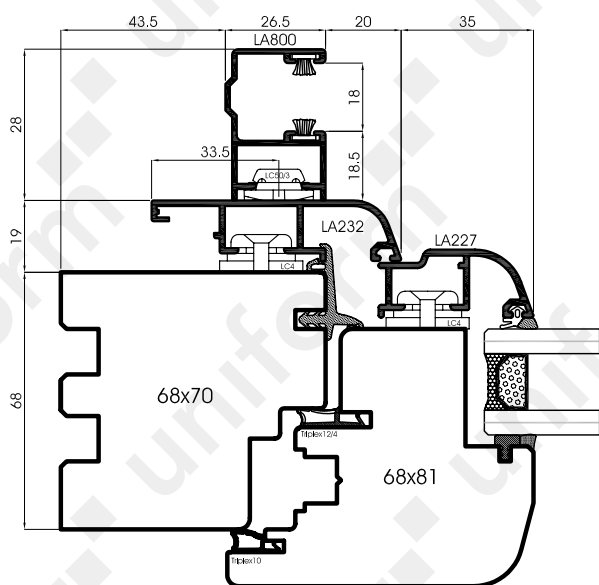
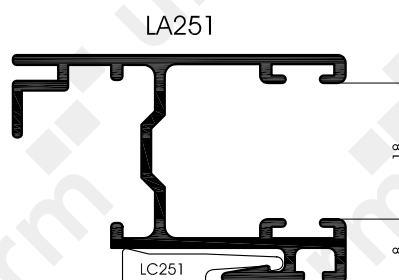
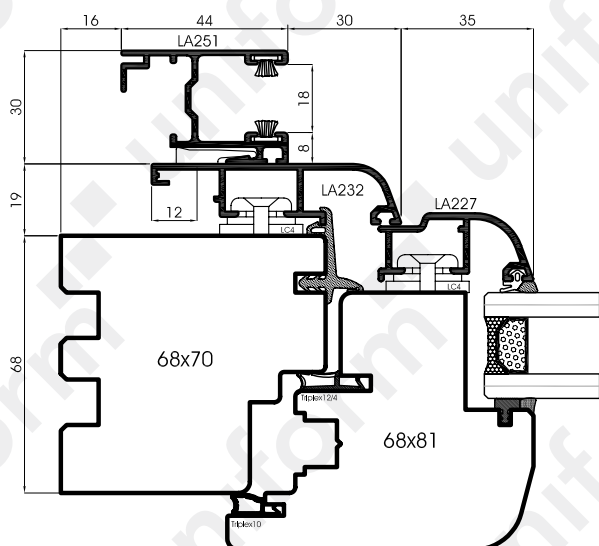
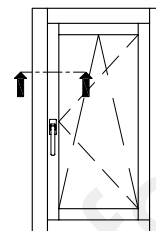
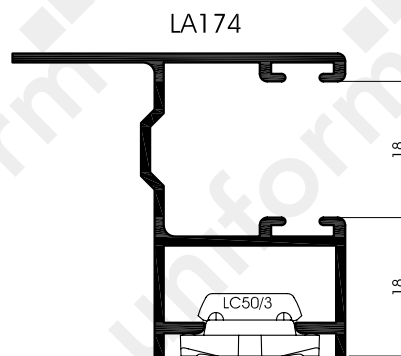
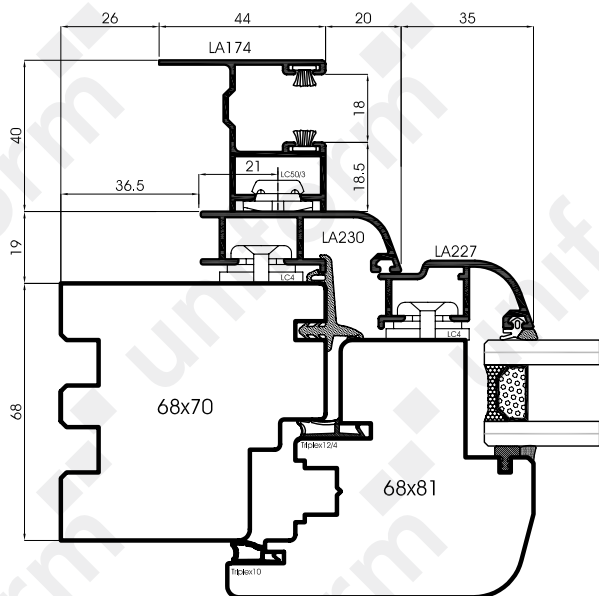

## Soft-Line

uniform

Scala 1:2

3.32

- Ⓘ Sezione orizzontale con guide avvolgibili LA174-LA251-LA800
- Ⓓ Vertikal- und Horizontalschnitt mit Rolladenführung LA174-LA251-LA800
- Ⓔ Sección horizontal con guías de persiana LA174-LA251-LA800
- Ⓕ Coupe horizontale avec coulisses volets roulants LA174-LA251-LA800
- Ⓖ Horizontal section with winding up guides LA174-LA251-LA800

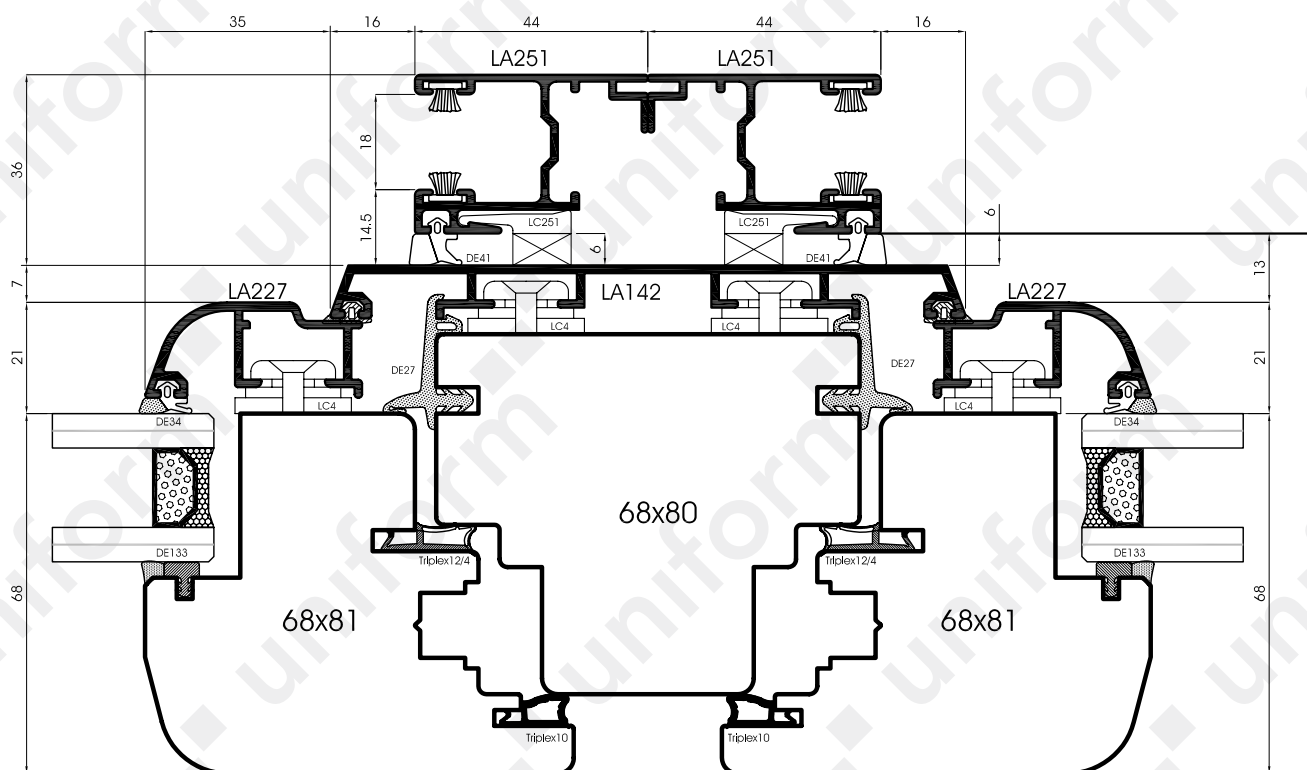
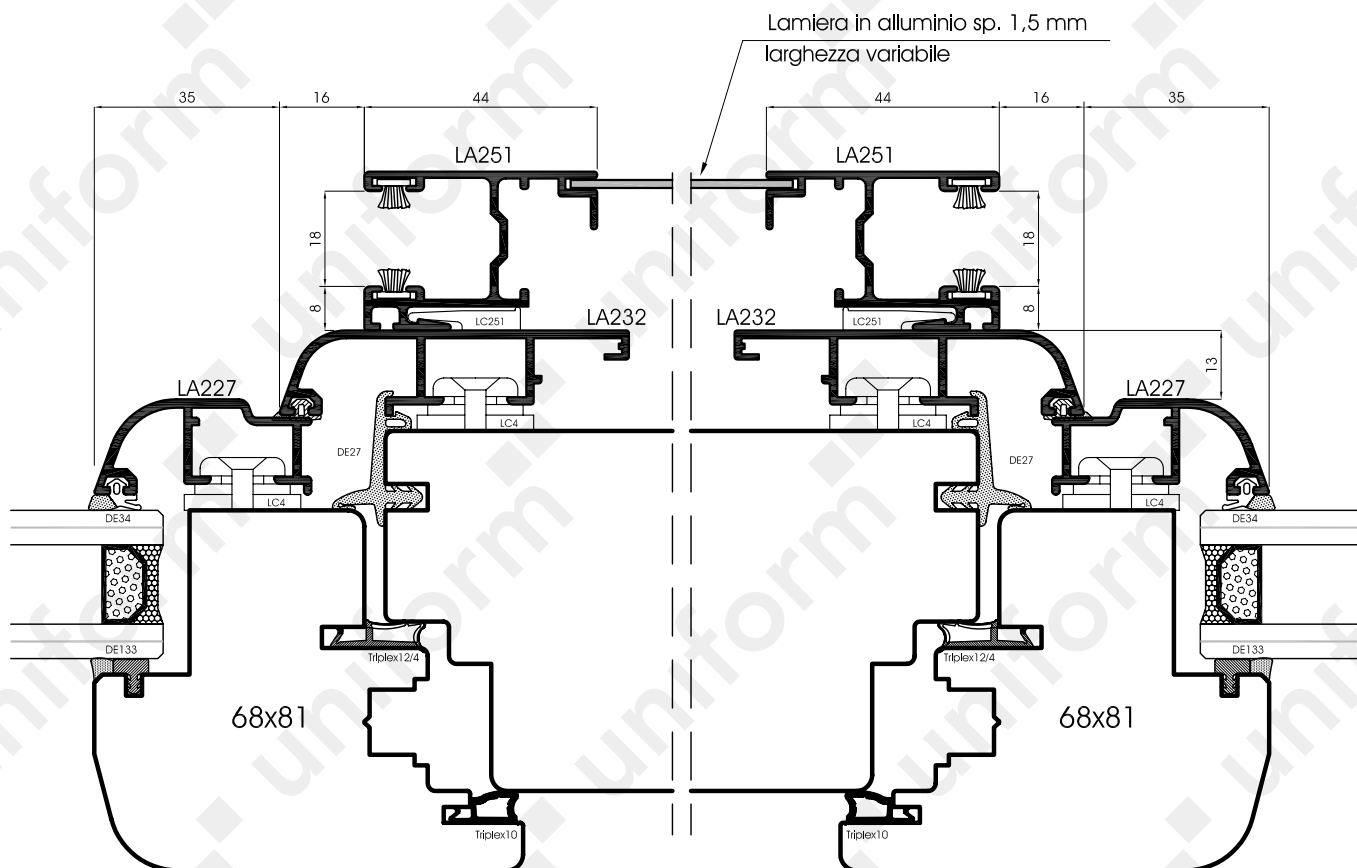

Soft-Line

uniform

Scala 0.7:1

3.33

- Ⓘ Sezione orizzontale finestre accoppiate con LA251
- Ⓓ Horizontalschnitt gekoppelte Fenster mit LA251
- Ⓔ Sección horizontal de ventanas acopladas
- Ⓕ Coupe horizontale accouplement de dormants avec LA251
- Ⓚ Horizontal section of the connected windows with LA 251

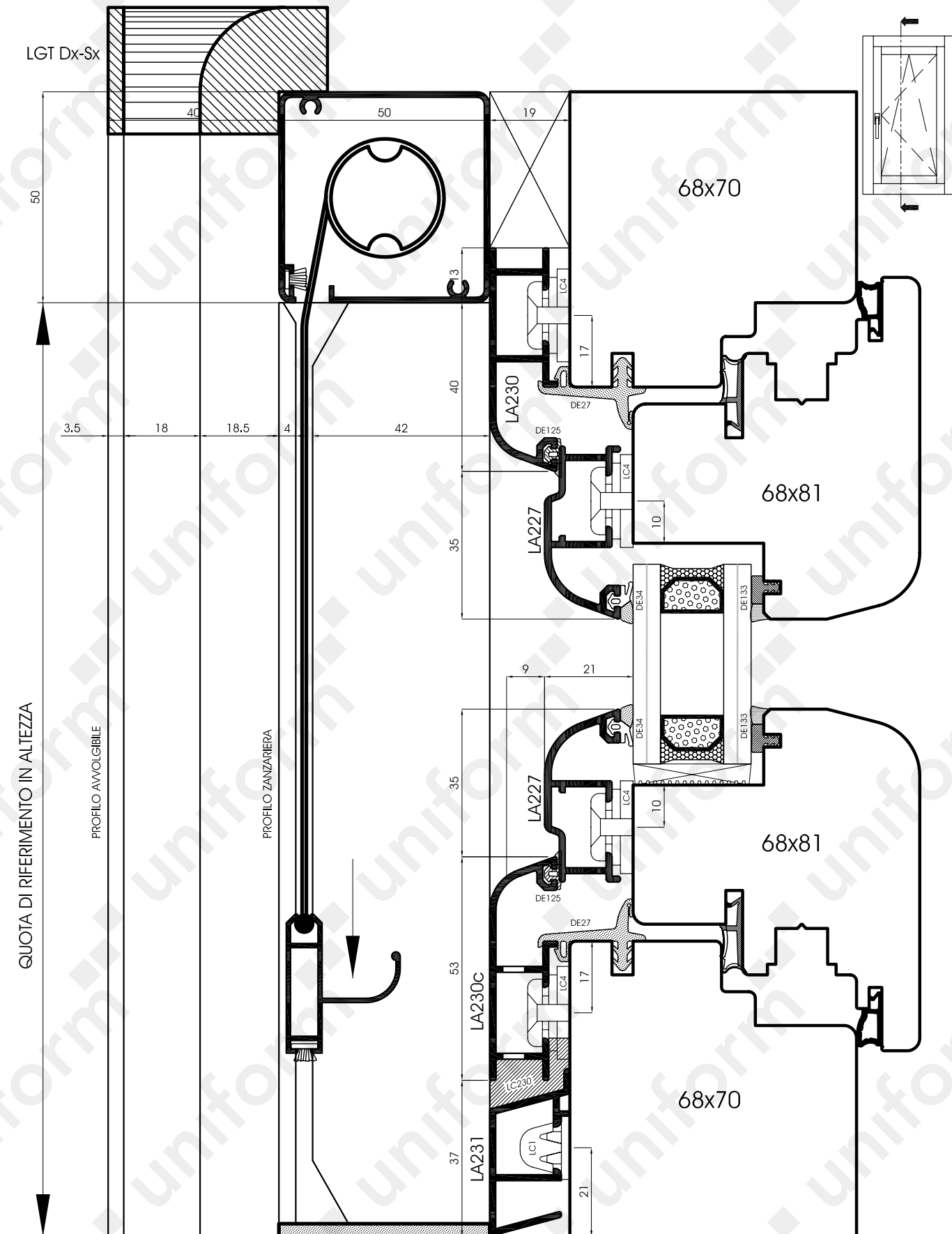

Disponibile su richiesta rallentatore di salita per zanzariera.  
 Uso consigliato per zanzariere con altezza superiore a 180cm.

Soft-Line

uniform

Scala 0.7:1

3.34

- Ⓘ Sezione verticale con zanzariera e guida avvolgibile
- Ⓓ Vertikalschnitt mit Fliegengitter und Rolladenführung
- Ⓔ Sección vertical ventana con mosquitera y guía de persiana
- Ⓕ Coupe verticale avec moustiquaire et coulisses volet roulant
- Ⓚ Vertical section with mosquito-net and winding up guide

Variante senza guida avvolgibile

ZANZARIERE - DIMENSIONI MASSIME REALIZZABILI:

- L 2000 x H 1600 - Finestra Verticale
- L 1600 x H 2400 - Portafinestra Verticale
- L 1500 x H 2500 - Scorrimento orizzontale 1 anta
- L 2800 x H 2500 - Scorrimento orizzontale 2 ante

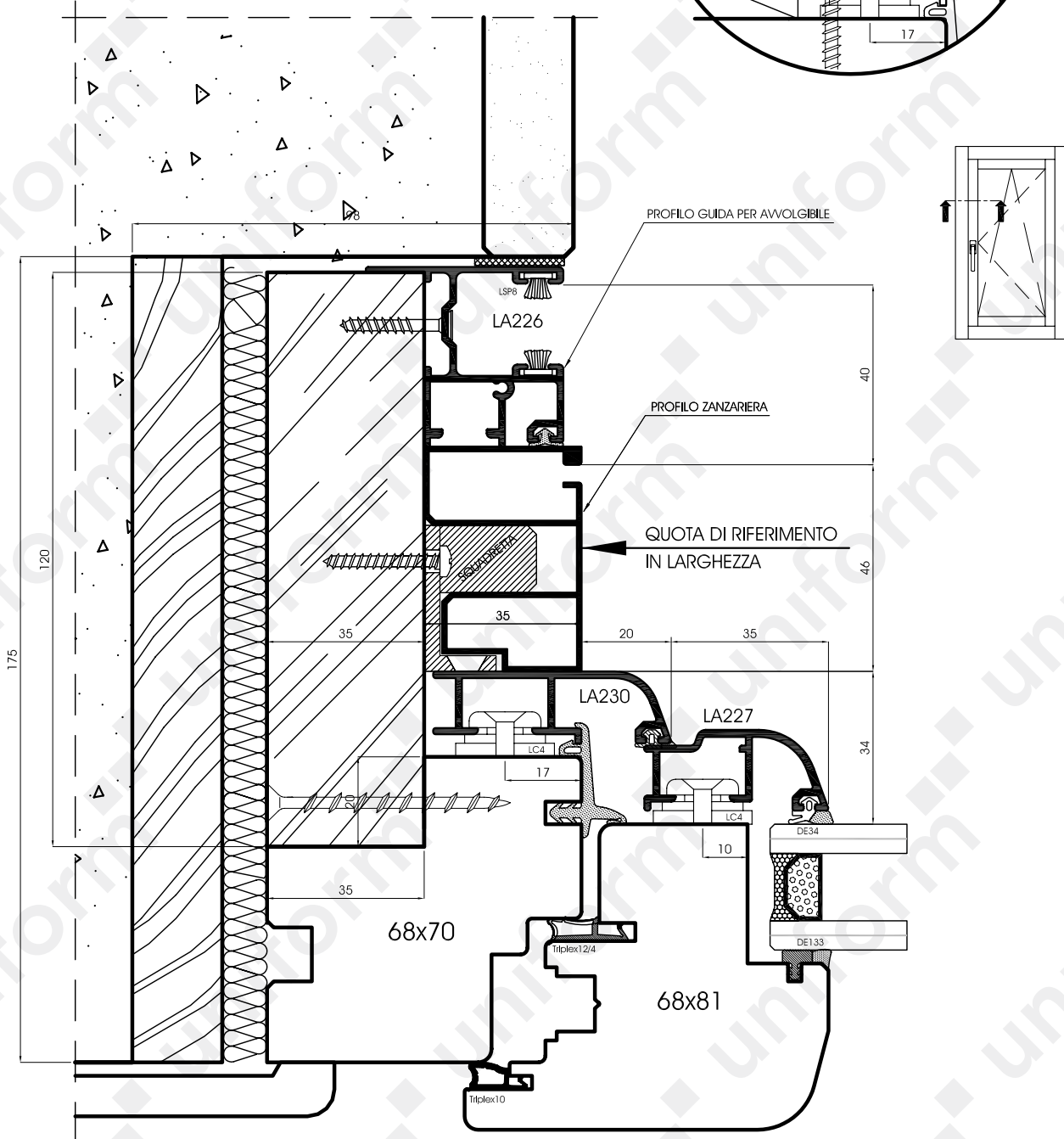
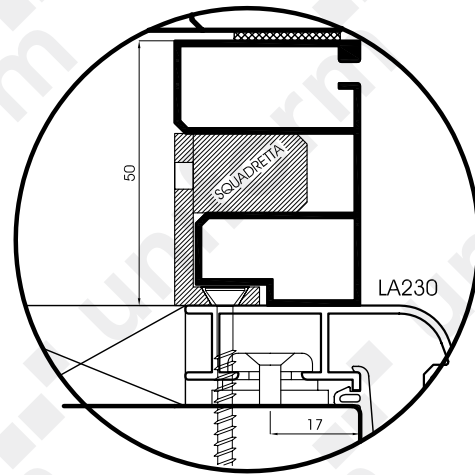

Soft-Line

uniform

Scala 0.7:1

3.35

- Ⓘ Sezione orizzontale con zanzariera e guida avvolgibile
- Ⓓ Horizontalschnitt mit Fliegengitter und Rolladenführung
- Ⓔ Sección horizontal ventana con mosquitera y guía de persiana
- Ⓕ Coupe horizontale avec moustiquaire et coulisse volet roulant
- Ⓚ Horizontal section with mosquito-net and winding up guide

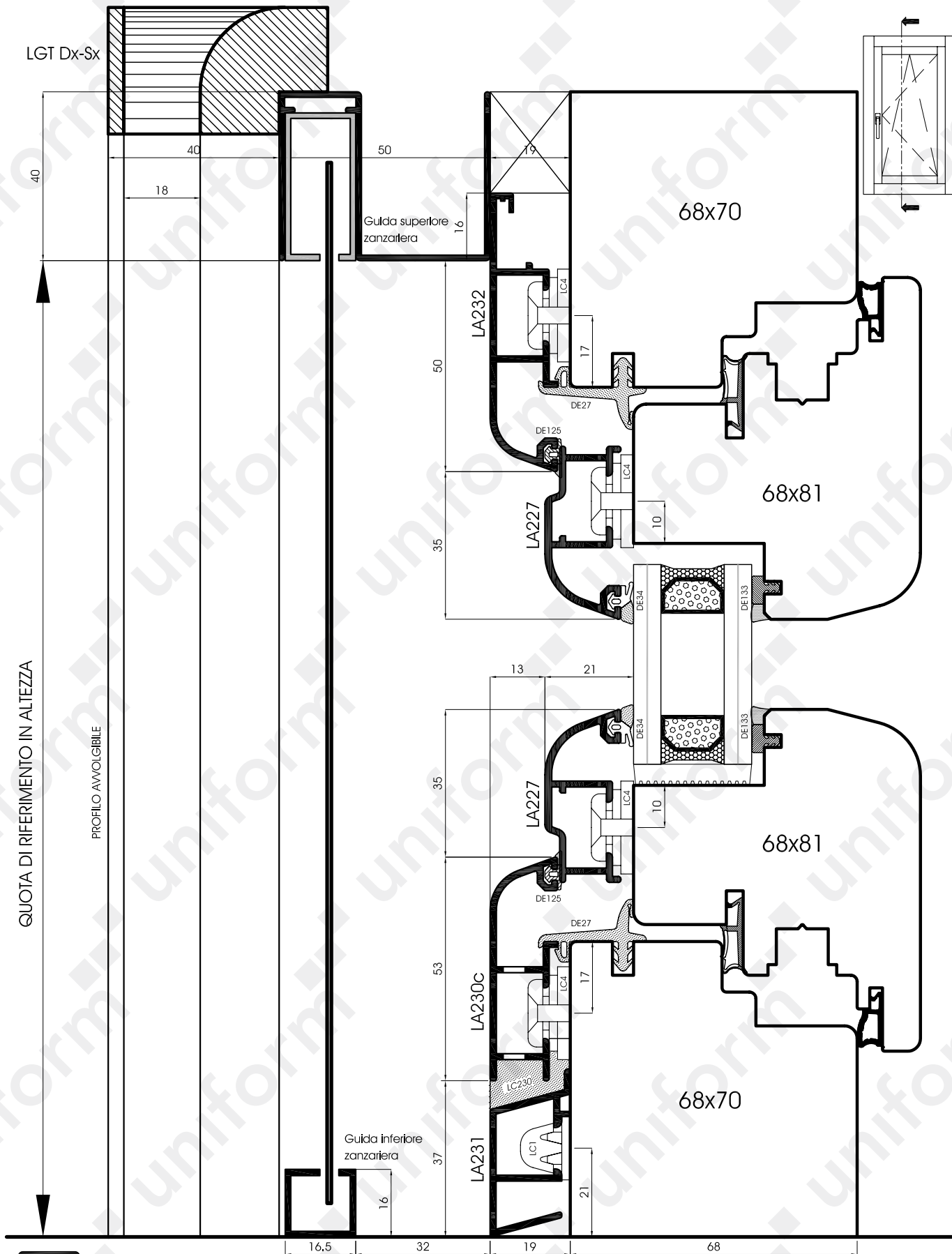

Disponibile su richiesta rallentatore per zanzariera. Uso consigliato per zanzariera con altezza superiore a 180cm.

Soft-Line



Scala 0.7:1

3.36

- ① Sezione verticale con zanzariera a scorrimento laterale e guida avvolgibile
- ② Vertikalschnitt mit Fliegengitter und Rolladenführung
- ③ Sección vertical ventana con mosquitera y guía de persiana
- ④ Coupe verticale avec moustiquaire et coulisses volet roulant
- ⑤ Vertical section with mosquito-net and winding up guide



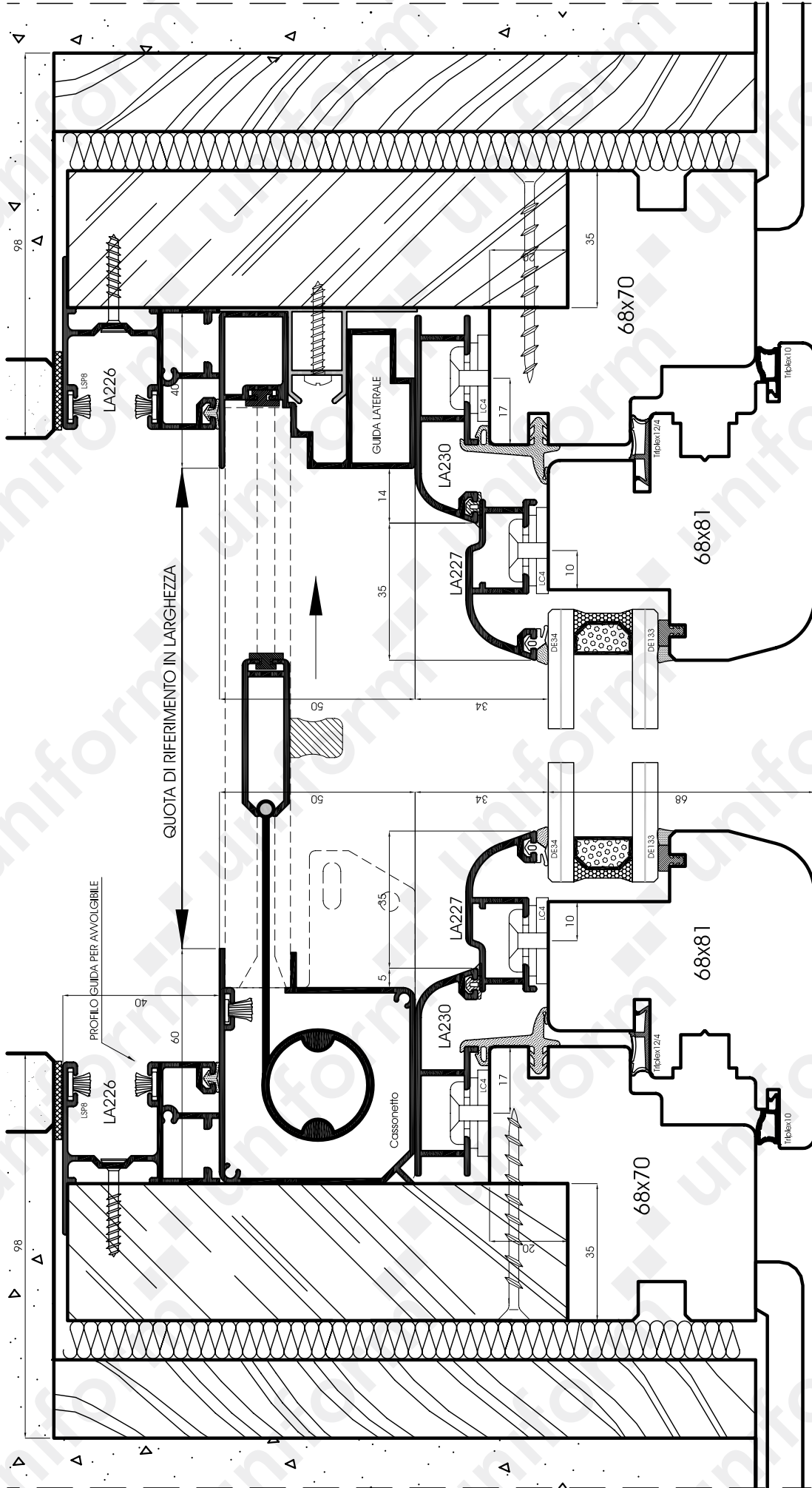

Soft-Line

uniform

- I Sezione orizzontale con zanzariera a scorrimento laterale e guida avvolgibile
- D Horizontalschnitt mit Fliegengitter und Rolladenführung
- E Sección horizontal ventana con mosquitera y guía de persiana
- F Coupe horizontale avec moustiquaire et coulisse volet roulant
- UK Horizontal section with mosquito-net and winding up guide

Scala 0.7:1

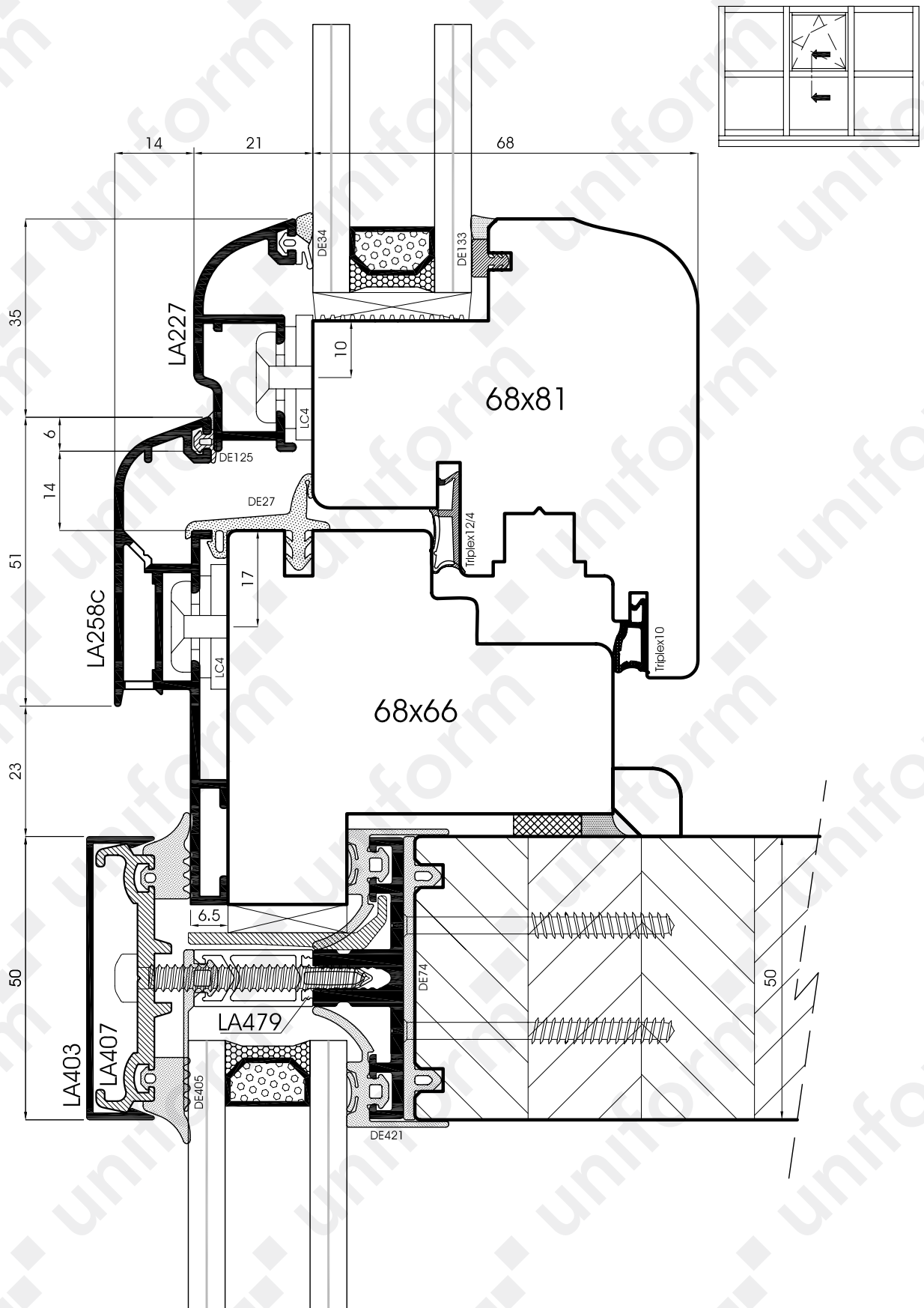

Soft-Line

uniform

Scala 1:1

3.38

- Ⓘ Sezione verticale traversi con facciata Unitherm
- Ⓓ Vertikalschnitt Fassade Unitherm - Riegel
- Ⓔ Sección vertical travesaños con fachada Unitherm
- Ⓕ Coupe verticale des traverses avec façade Unitherm
- Ⓚ Vertical section of ledgers with Unitherm curtain wall

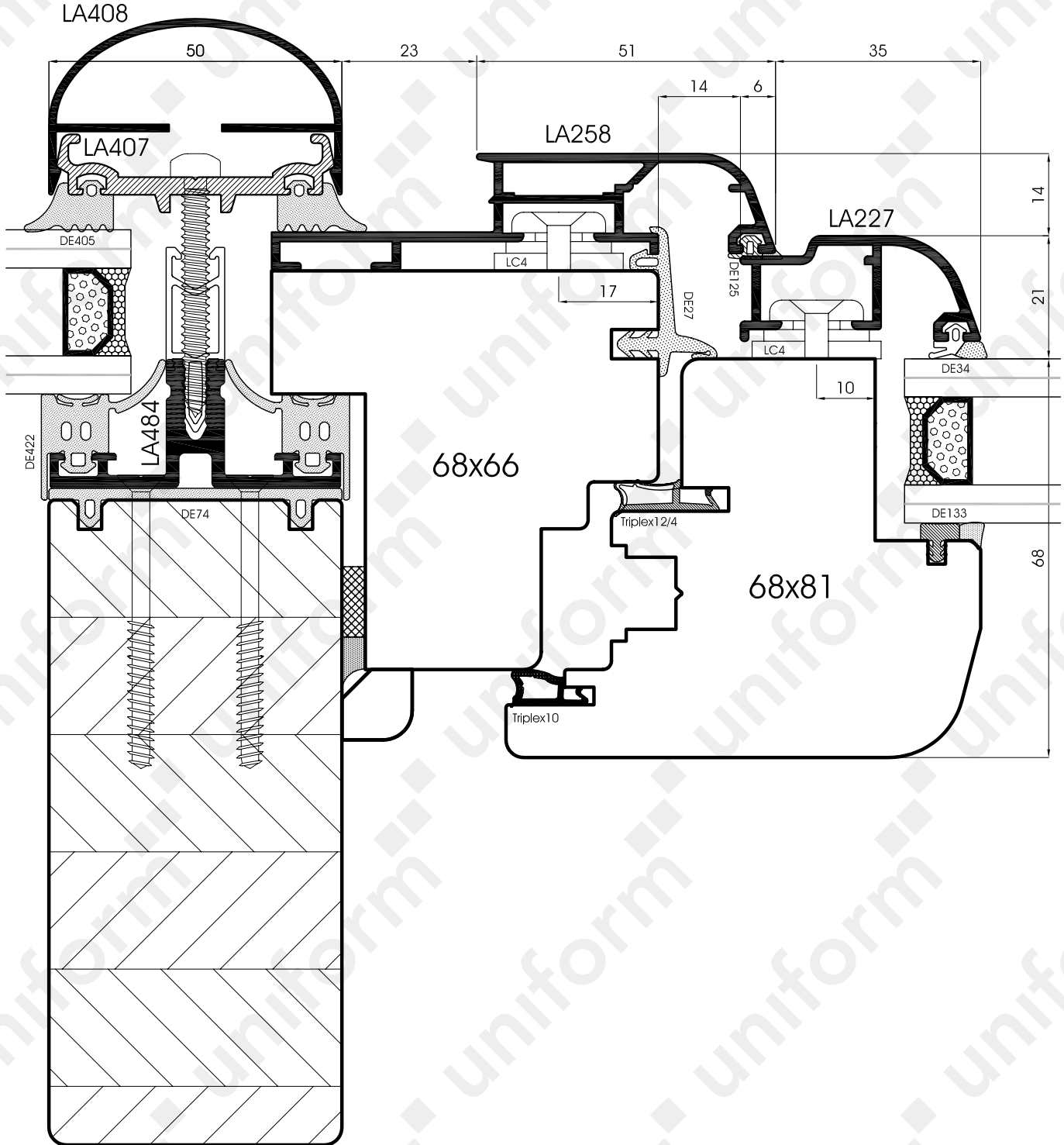
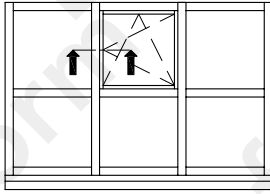

Soft-Line

uniform

Scala 1:1

3.39

- Ⓘ Sezione orizzontale montanti con facciata Unitherm
- Ⓓ Horizontalschnitt Fassade Unitherm - Pfosten
- Ⓔ Sección horizontal montantes con fachada Unitherm
- Ⓕ Coupe horizontale des montants avec façade Unitherm
- Ⓚ Vertical section of jambs with Unitherm curtain wall